

Current monitoring relay GRI8-01...04

Instruction Manual

General



■ Applications

-Serves for monitoring of heating in rail-switches, heating cables, consumption of one-phase motors, indicates current flow.

■ Function Features

- Adjustable delay 0.5 - 10 s to eliminate short current peaks.
- Flexible adjustment by potentiometer, choice of 6 ranges :
AC 0.05-0.5A; AC 0.1-1A; AC 0.2-2A; AC 0.5-5A; AC 0.8-8A; AC 1.6-16A
- Possible to use for current scanning from current transformer.
- Universal supply AC/DC 24 - 240 V.
- Relay status is indicated by LED.
- 1-MODULE,DIN rail mounting.

■ Model and connotation

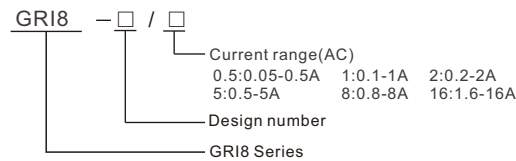

Technical parameters

Technical parameters	GRI8-01	GRI8-02	GRI8-03	GRI8-04
Function	Over action	Under action	Over/under	Over and under
Supply terminals	A1-A2			
Rated supply voltage	AC/DC 24V-240V			
Rated supply frequency	50/60Hz,0			
Burden	max 2VA			
Supply voltage tolerance	-15%;+10%			
Current range(AC)	0.5A, 1A, 2A, 5A, 8A, 16A			
Current adjustment	potentiometer			
Time delay	adjustable 0.1-10 s			
Power up delay	adjustable 0.1-10 s			
Supply indication	green LED			
Setting accuracy	10 %			
Repeat accuracy	<1 %			
Temperature dependancy	< 0.1 % /°C			
Limit values tolerance	5 % (10% for 0.05-0.5A range)			
Hysteresis	5 %			
Temperature coecient	0.05%/°C, at=20°C(0.05°F , at=68°F)			
Output	1×SPDT			
Current rating	10A/AC1			
Switching voltage	250VAC/24VDC			
Min.breaking capacity DC	500mW			
Output indication	red LED			
Mechanical life	1×10 ⁷			
Electrical life(AC1)	1×10 ⁵			
Operating temperature	-20°C to +55°C (-4°F to 131°F)			
Storage temperature	-35°C to +75°C (-22°F to 158°F)			
Mounting/DIN rail	Din rail EN/IEC 60715			
Protection degree	IP40 for front panel/IP20 terminals			
Operating position	any			
Overvoltage cathogory	III.			
Pollution degree	2			
Max.cable size(mm ²)	solid wire max.1×2. 5or 2×1. 5/with sleeve max.1×2. 5(AWG 12)			
Tightening torque	0.8Nm			
Dimensions	90×18×64mm			
Weight	69g			
Standards	IEC60947-5-1			

Panel Diagram

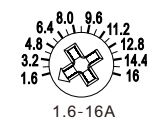
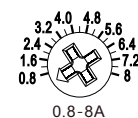
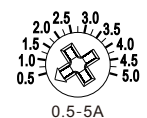
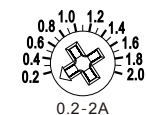
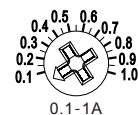
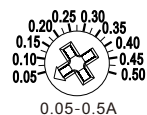
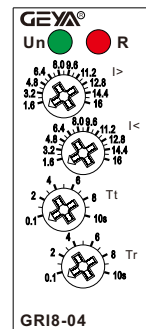
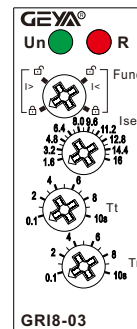
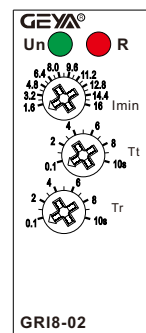
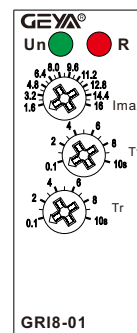

Wrong setting of GRI8-03

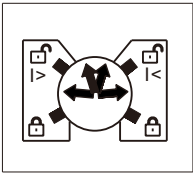

As shown in the figure above, they are wrong settings. In that cases, LED- Un and LED-R will flash at the same time, which indicate the setting error. Normal operation will be resumed through resetting after power-off.

If the operating function is changed after power-on, the two LED indicators would flash while the relay operates based on original operating functions; the LED would resume the normal indication after the original setting is recovered.

Wrong setting of GRI8-04

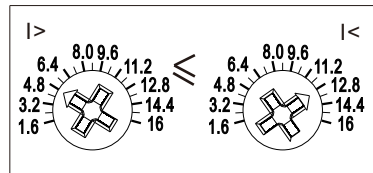

The set over-current threshold value must be larger than under-current threshold value. Otherwise, the two LEDs would flash and the output relay would be disconnected.

Functions Diagram

GRI8-01

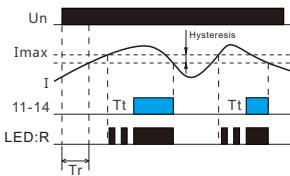

GRI8-02

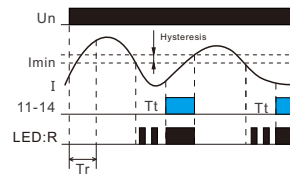

GRI8-03

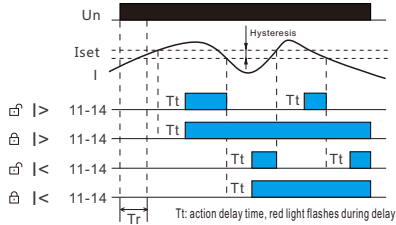

GRI8-04

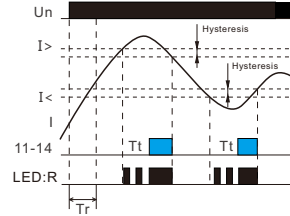

T_r : Power up delay.
 T_t : Tripping delay.

Wiring Diagram

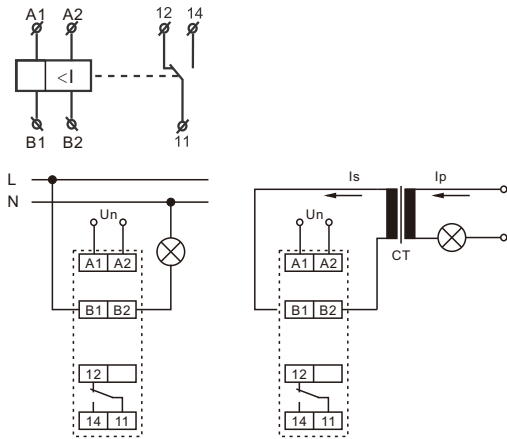

Dimensions(mm)

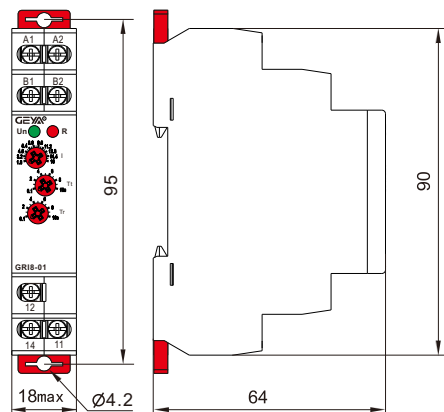

Disposal of Electrical Waste
All electrical waste should be disposed of in compliance with current WEEE regulations.



Caution
The products must be installed by qualified electricians. All and any electrical connections of the product shall comply with the appropriate safety standards.